

Cäm

EN HD Video Baby Camera and Monitor

UA HD-

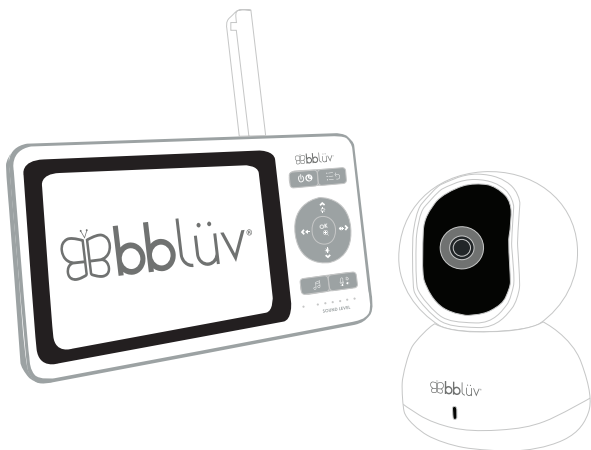

Please read the instruction manual carefully before use.

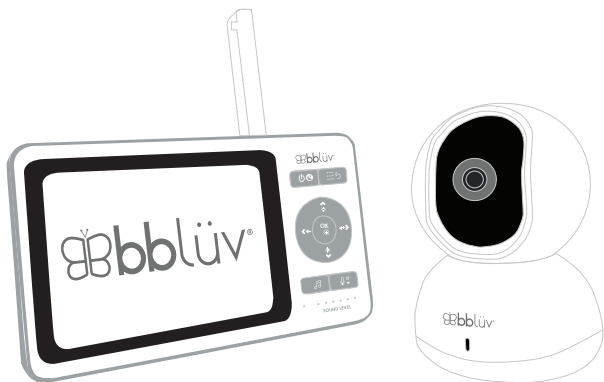

2 x



2 x

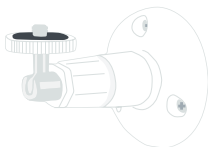

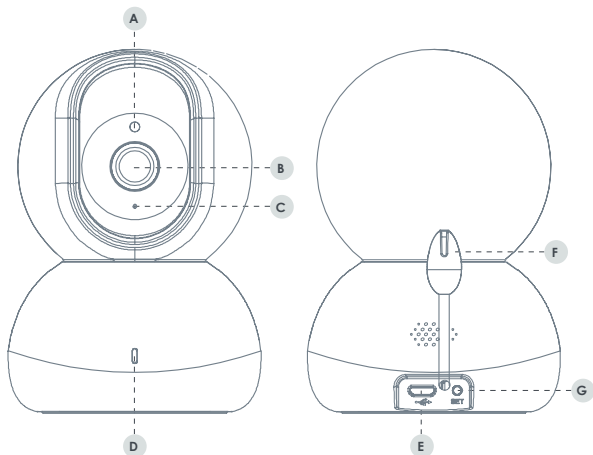

A
Photosensitive sensor

D
Status indicator

G
SET button
SET

B
Lens

E
Power socket

C
Microphone

F
Temperature sensor

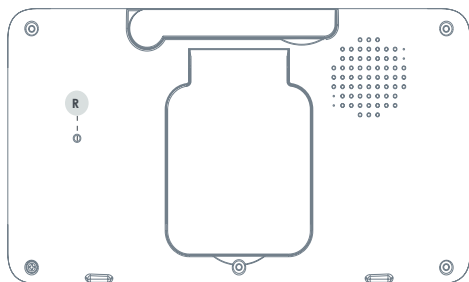
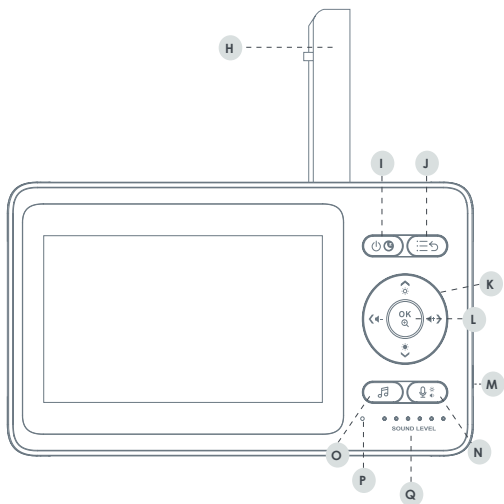

H

Antenna

N

Talk / Adjust button

/

I

ON / OFF / ECO mode

/ /

O

Play music button

J

Menu / Return button

/

P

Microphone

K

Navigation button

Q

Sound level and status indicator

L

OK / Select button







/







R



RESET button

M

Power socket

	No signal connection between the monitor and the camera.
	The strength of the signal between the monitor and the camera.
	Indicates the reference camera.
	The Lullaby function is enabled.
27°C	Displays the current room temperature.
	Show current battery level.
	The temperature alert has been turned on and indicates which camera it has been activated for.

	The Feeding reminder has been turned on.
	The audible alarm has been turned on and indicates which camera it has been activated for.
	Sound sensitivity alert
	No camera connected or the camera is disconnected from the receiver.
	Temperature alert
	The Standby timer has been turned on.
	Low battery alert

	The microphone is activated. You can talk to your baby.
	Alarm alert
 SOUND LEVEL	The first to fifth green indicators flashing from low to high indicate the volume of the monitor; the sixth red indicator glowing steadily indicates the battery is charging. (displayed whether it is powered on or off)

1.

(E)



2.

(

3.)

()

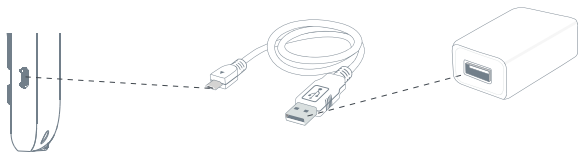

3.

ON/OFF (. /) (I),

MENU (J).

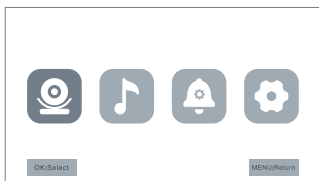

MENU (J),

- 1.
 2. (J).
 - 3.
 4. +
- OK

MENU



OK.

OK.

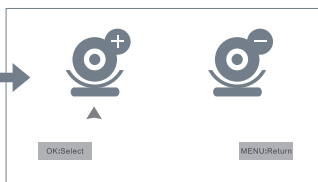
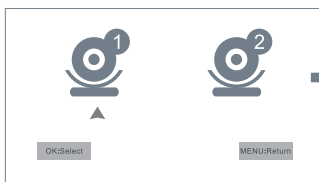

5. Start pairing (),
SET () (G)

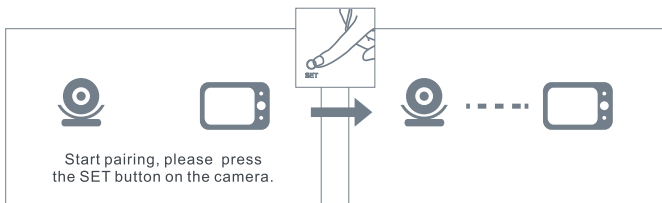

1. MENU (J),
2. OK.
3. OK.
4. -
OK

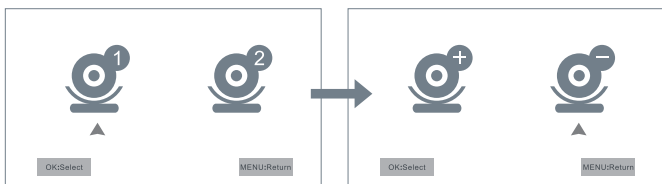

1.

MENU

(J)

2.



3.

OK,

All (),

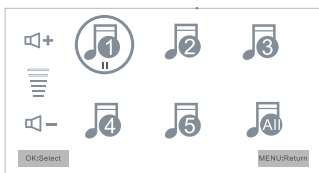

4.

MENU (J)
MENU (J)

5.



1.

MENU

(J)

2.



3.

Low, Middle, High,
MENU (J)

Off -

OK.

MENU

(J)

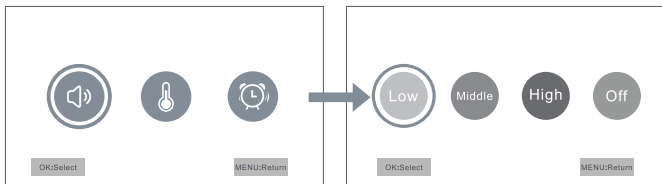

ON/OFF,

ALARM SOUND/

1.

MENU (J),

2.

OK,

3.



°C

°F

OK

ON

OFF

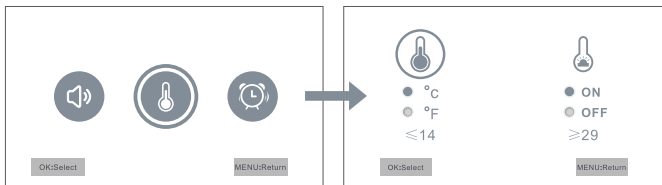

4.

OK

OK
MENU (J),
MENU (J)

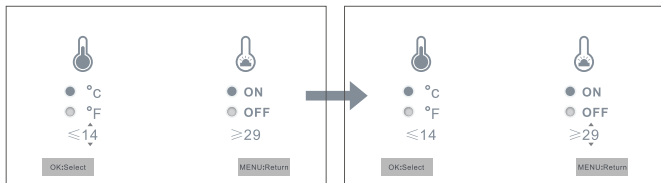

3

ON/OFF,

ALARM SOUND (

1

1.

MENU (J),

2.



OK,

3.



OK.

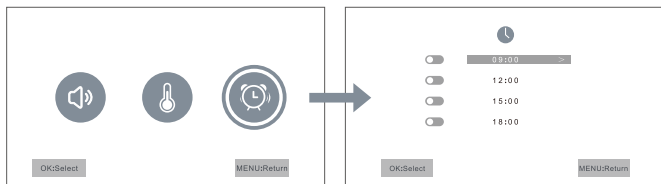

4.

OK
MENU (J),
MENU (J)

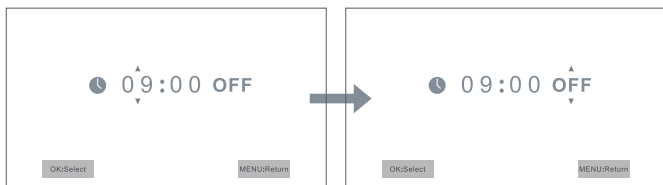

ALARM SOUND()

1.

MENU (J),

2.

OK,

3.

ON

OFF

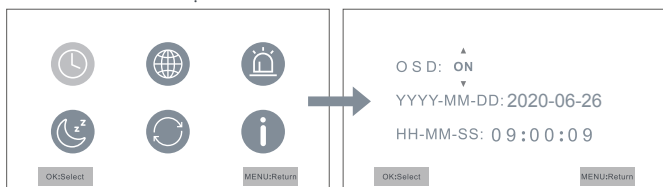

MENU (J)

1.

MENU (J),

2.



OK,

3.



MENU (J),

1.

MENU (J),

2.



OK,

3.



MENU (J),

1.

MENU (J),

2.



OK,

3.



20,

40 60

MENU (J),

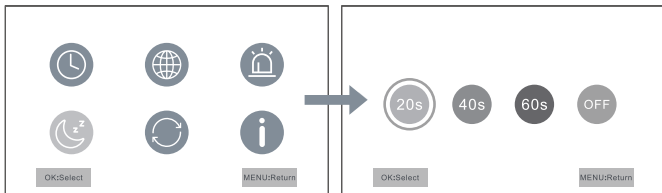

ECO (ON/OFF/ECO)

(I)

1.

MENU (J),

2.



OK,

3.



OK

YES

NO
YES,
NO,

MENU (J),

1.

MENU (J)

2.

OK,



3.



MENU (J),

OK

1

OK,

Talk/Adjust

(N)

N.



Căm

•

•

•

	<ol style="list-style-type: none"> 1. , 2. ,
	<ol style="list-style-type: none"> 1. / : 2. / 3. 4.
	(up/down) /
&	<ol style="list-style-type: none"> 1. , 2. . 3. .

⚠

- : (3
-).

⚠

- Căm,
- .

- Căm



-
-
-
-
-
-
-

).

B

15

FCC.

15 FCC.

(1)

(2)

CE FCC

: FCC RF

0 1,545 /

FCC: <https://apps.fcc.gov/oetcf/eas/reports/GenericSearch.cfm> search for FCC ID: TW5GD7617 and TW5GD8217

2014/53 /

()

RSS,

Industry Canada.

(1)

(2)

()

():

(IC).

EU Environmental Protection

Waste electrical products should not be disposed of with household waste. Please recycle where facilities exist. Check with your local authority or retailer for recycling advice.



():

(IC).

IC

(

20

).

	1/6.5" CMOS
	640*480 P
	45 ± 5 °
	: 350 ° : 55 °
	3
	DC 5V/1A
	0°C~40°C
	-20°C~60°C
	15~85% RH
(* *)	75 x 75 x 109

-	4.3" - TFT
	480*272 P
	2.4 GHz FHSS
	DC 5V/1A
	0°C~40°C
	-20°C~60°C
	15 ~ 85%
(* *)	158 x 19 x 88

<https://bbluvgroup.com/product-re>

